

Kellergeschoss

7.1

7.2

7.3

7.4

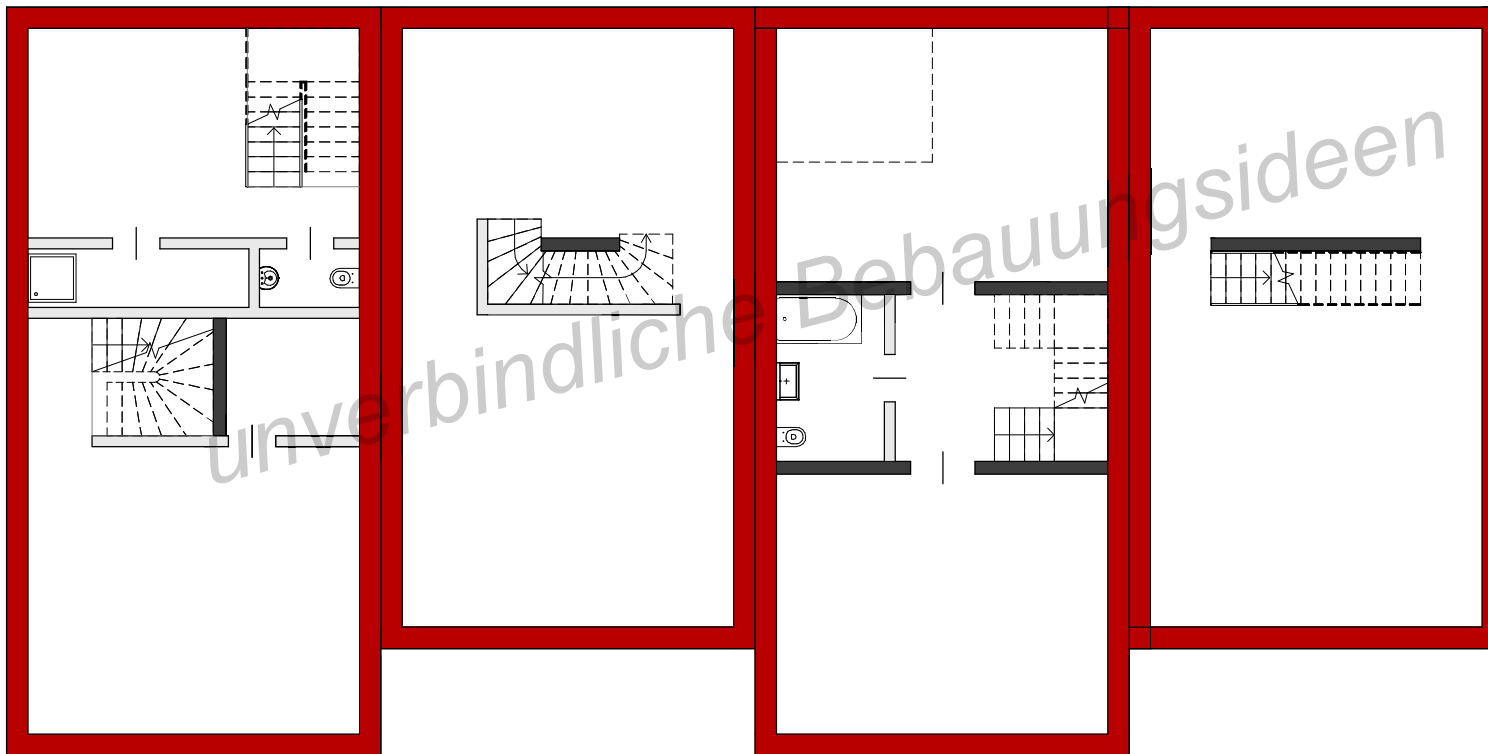

7.1

7.2

7.3

7.4

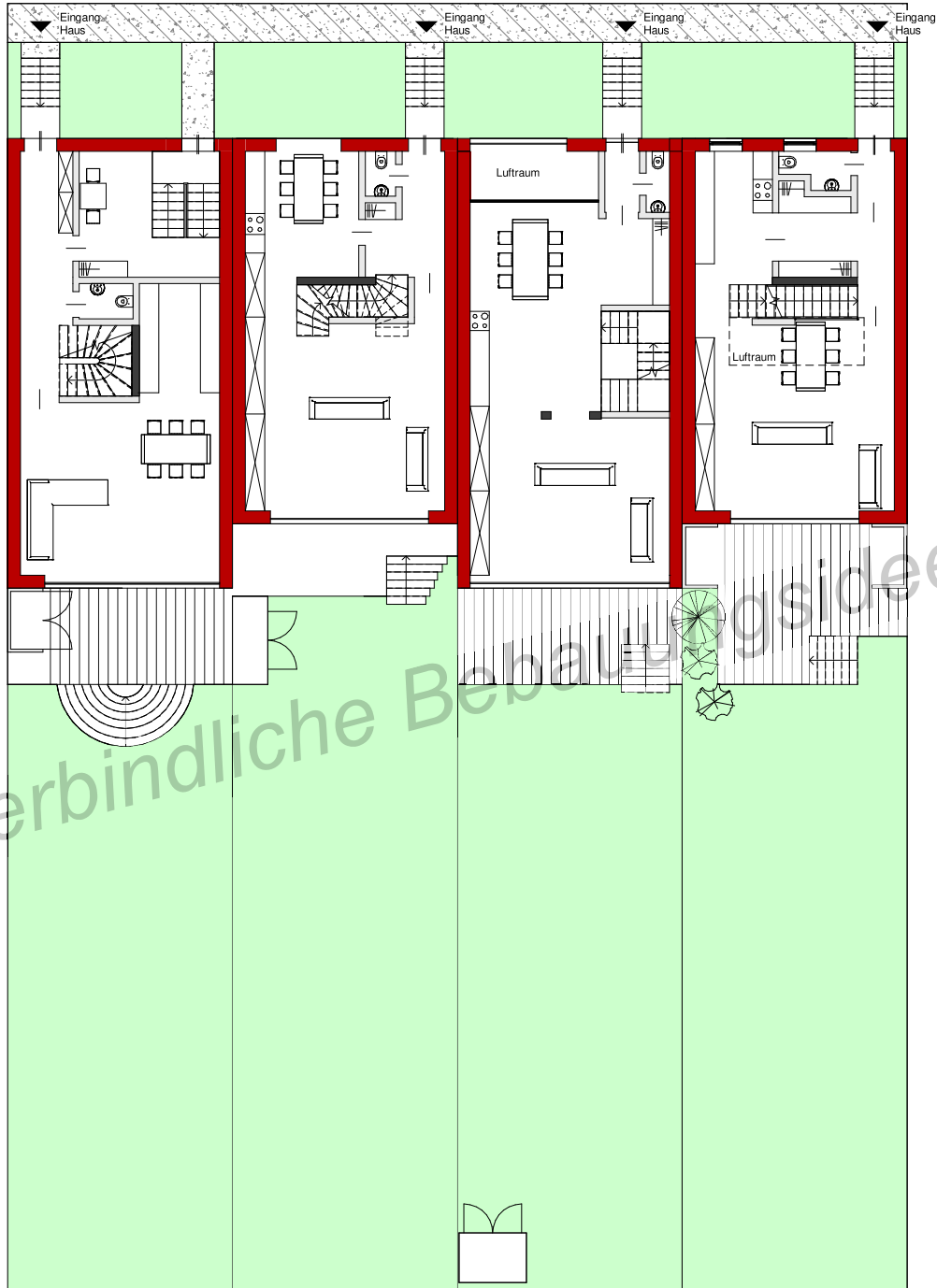

1.Obergeschoss

7.1

7.2

7.3

7.4

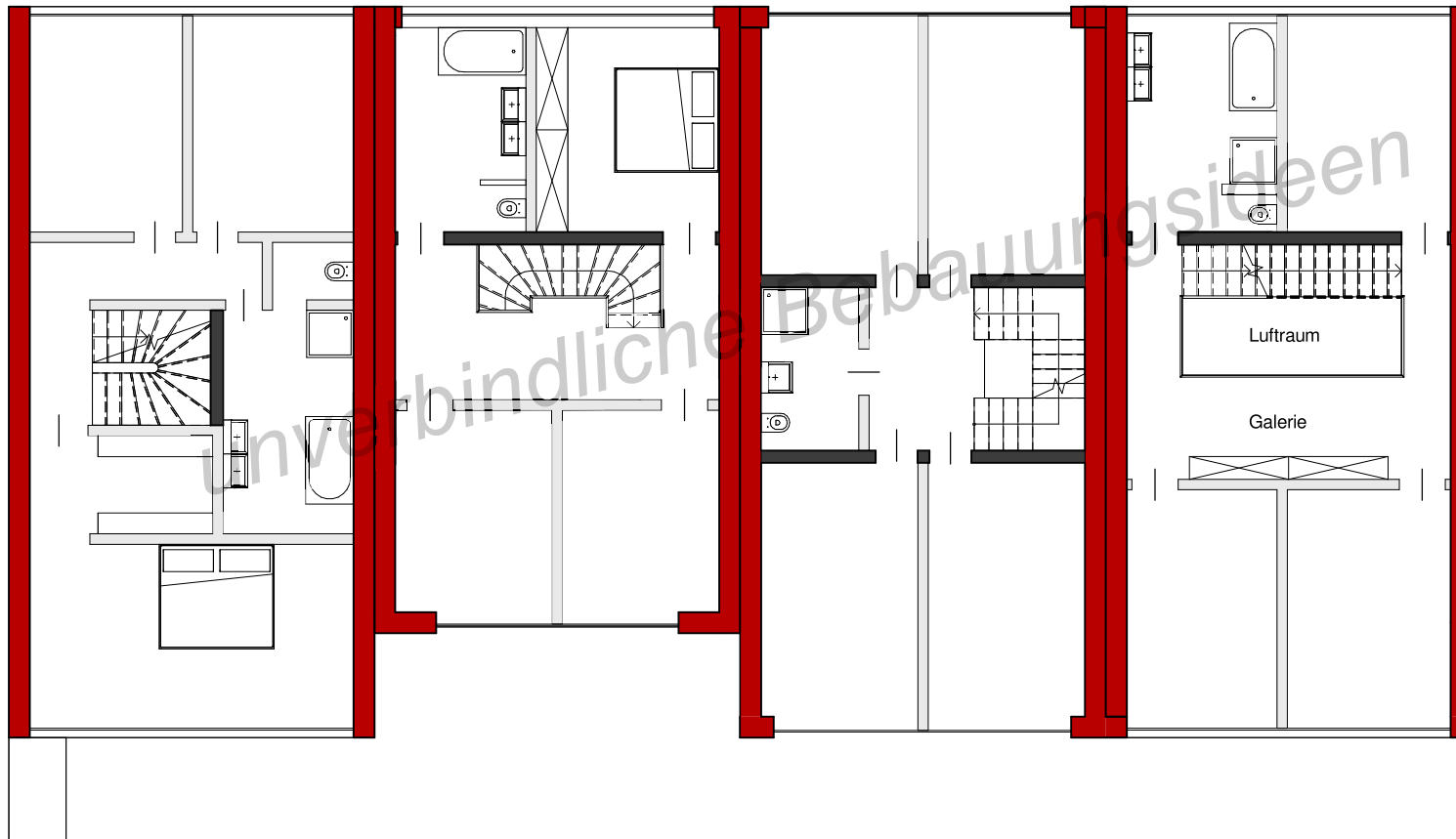

2.Obergeschoss

7.1

7.2

7.3

7.4

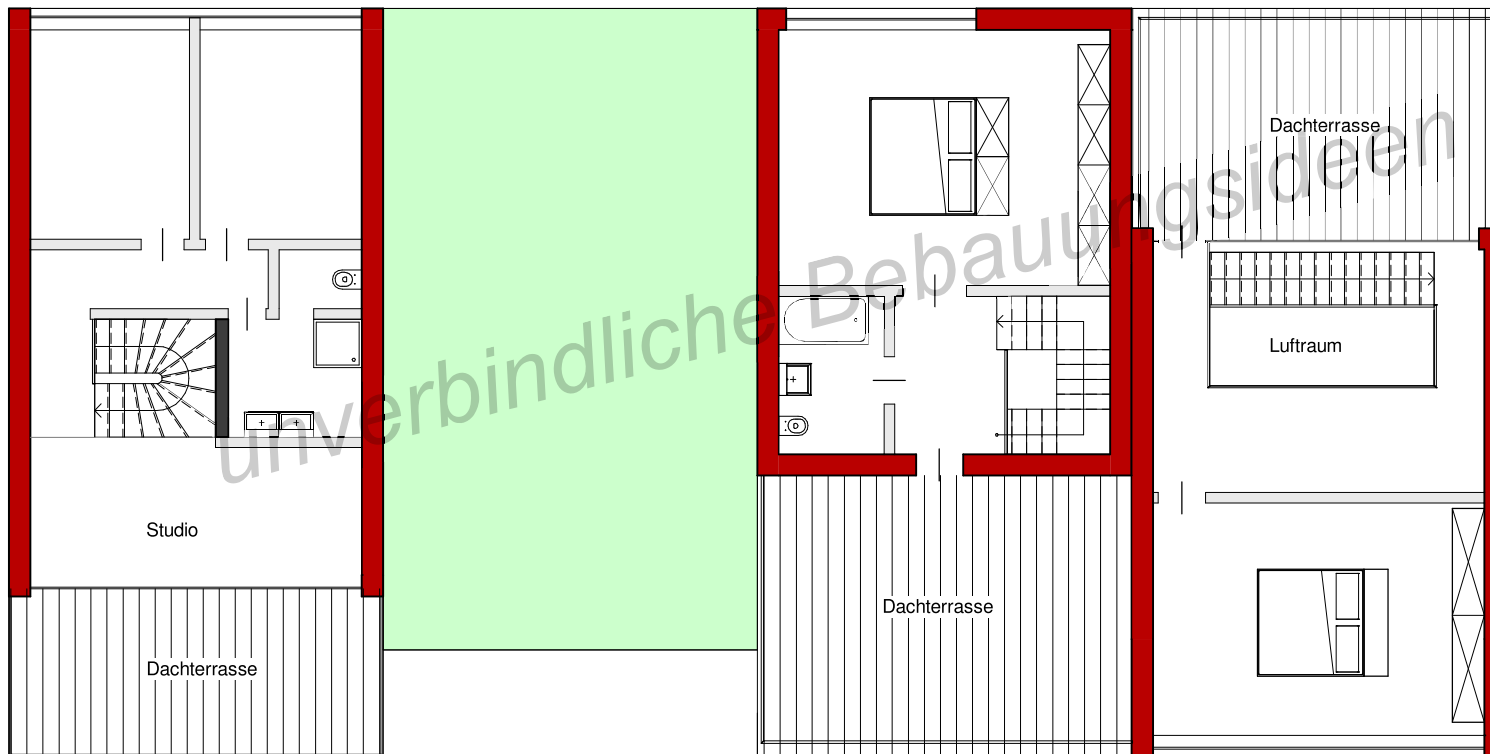

Ansicht Straßenseite

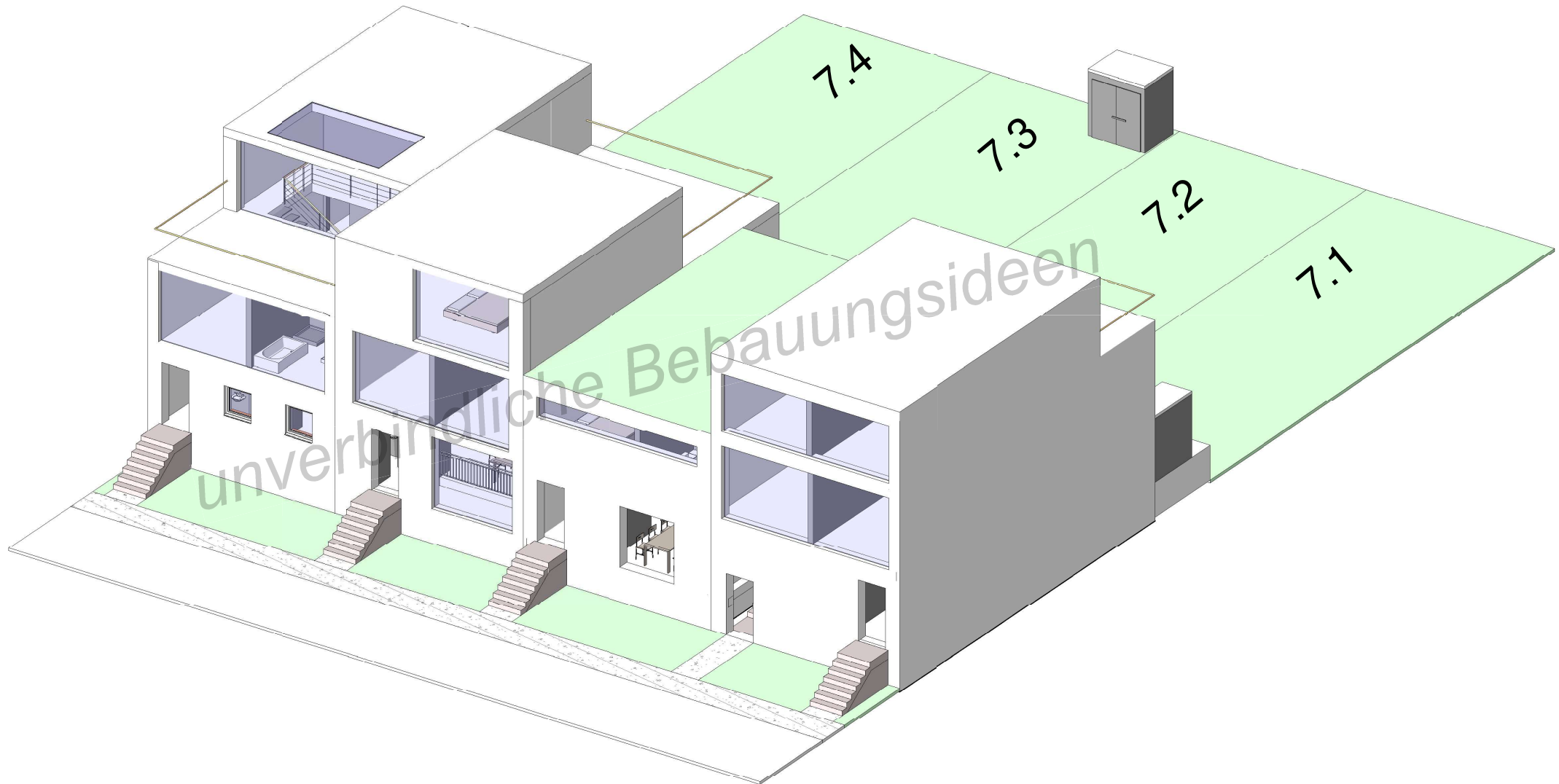

Ansicht Garten

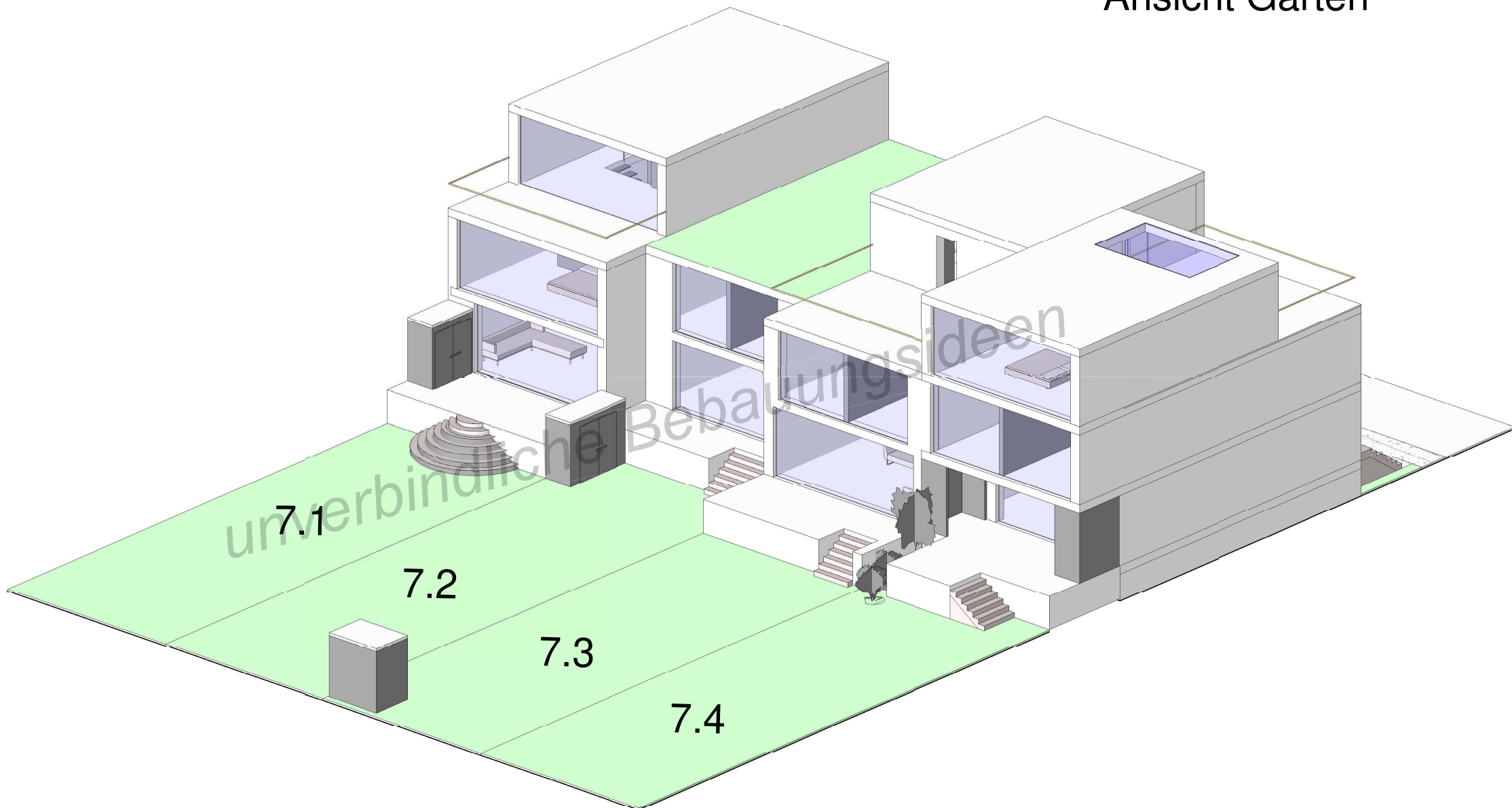

Reihenhaus Typ 7.1

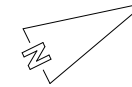

2.Obergeschoss

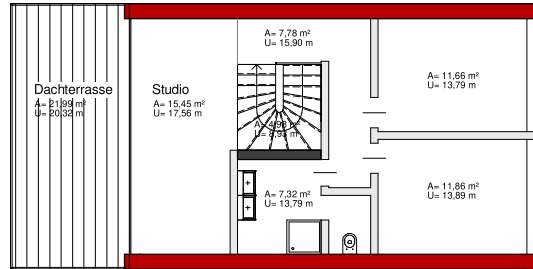

1.Obergeschoss

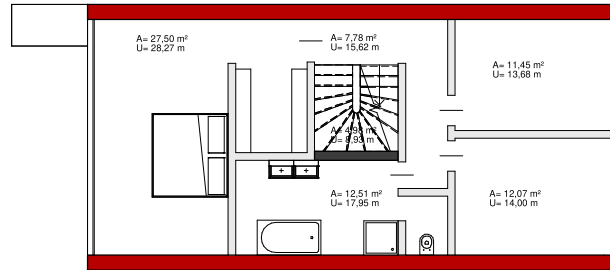

Erdgeschoss

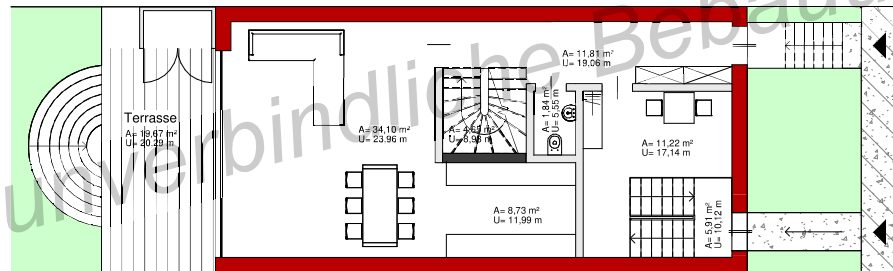

Kellergeschoss

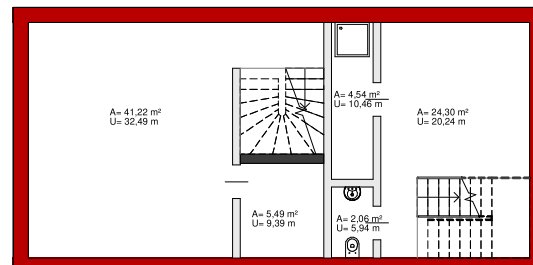

Raumbezeichnung	Fläche
Treppe	Nicht platziert
Nicht platziert	0,00 m ²

Raum	41,22 m ²
Dusche	4,54 m ²
Einliegerkeller	24,30 m ²
WC	2,06 m ²
Raum	5,49 m ²
1.KG	77,61 m ²

Eingang	11,22 m ²
Flur	11,81 m ²
Wohnen	34,10 m ²
Küche	8,73 m ²
WC	1,84 m ²
Treppe	4,65 m ²
Treppe	5,91 m ²
EG	78,26 m ²

Flur	12,07 m ²
Schlafen	27,50 m ²
Flur	7,78 m ²
Sanitär	12,51 m ²
Wohnen	11,45 m ²
Treppe	4,98 m ²
1.OG	76,30 m ²

Studio	15,45 m ²
Flur	7,78 m ²
Wohnen	11,66 m ²
Wohnen	11,86 m ²
Sanitär	7,32 m ²
2.OG	54,07 m ²
Gesamt: 24	286,23 m ²

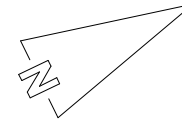

1.Obergeschoss

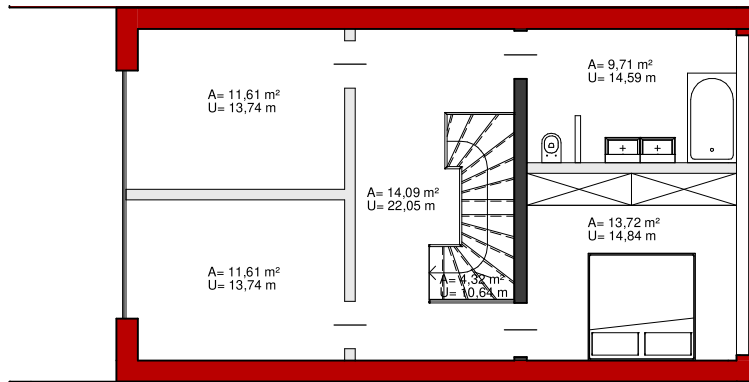

Reihenhaus Typ 7.2

Raumbezeichnung	Fläche
-----------------	--------

Raum	36,21 m ²
Raum	31,80 m ²
1.KG	68,01 m ²

Eingang	8,82 m ²
Wohnen	36,94 m ²
Essen	15,62 m ²
WC	1,33 m ²
Raum	3,78 m ²
EG	66,48 m ²

Flur	14,09 m ²
Raum	11,61 m ²
Raum	11,61 m ²
Sanitär	9,71 m ²
Schlafen	13,72 m ²
Treppe	4,32 m ²
1.OG	65,07 m ²
Gesamt: 13	199,56 m ²

Erdgeschoss

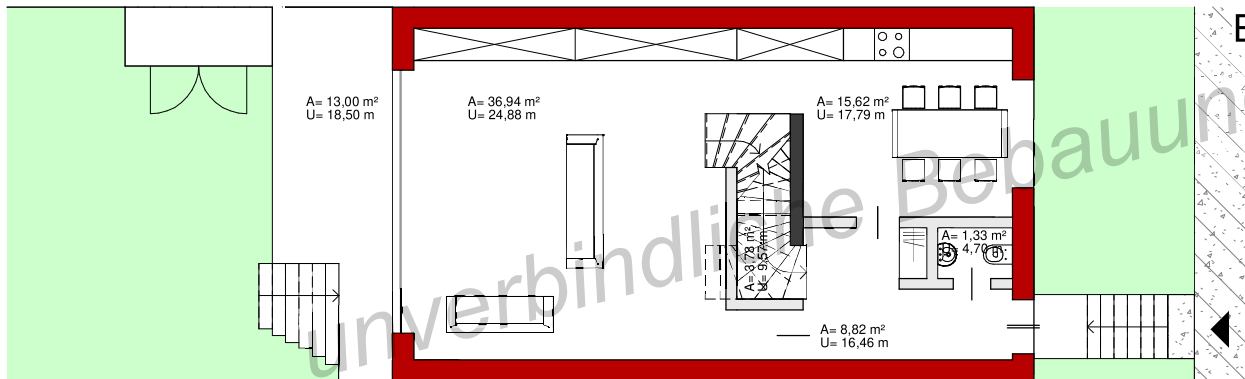

Kellergeschoss

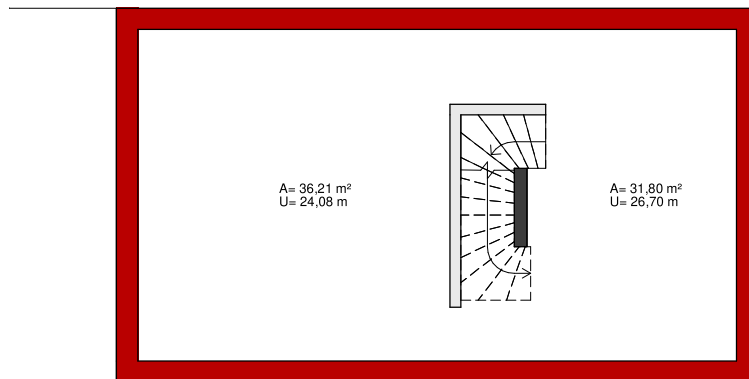

2. Obergeschoss

Reihenhaus Typ 7.1

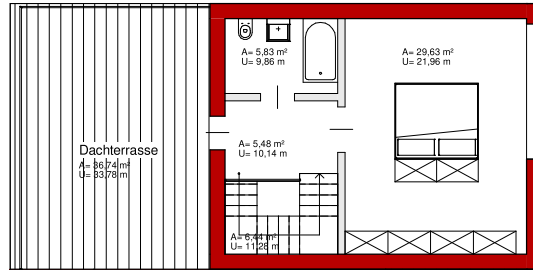
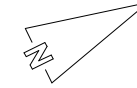

1. Obergeschoss

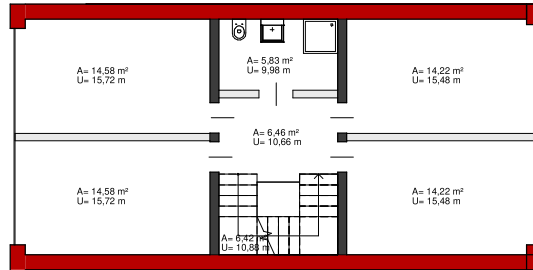

Erdgeschoss

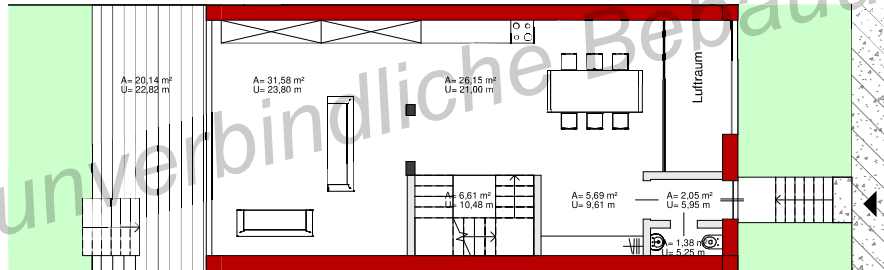

Kellergeschoss

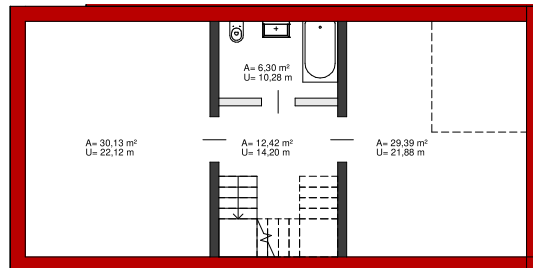

Raumbezeichnung	Fläche
-----------------	--------

Flur	12,42 m ²
Raum	30,13 m ²
Sanitär	6,30 m ²
Raum	29,39 m ²
1.KG	78,24 m ²

Flur	5,69 m ²
Essen	26,15 m ²
Wohnen	31,58 m ²
WC	1,38 m ²
Windf.	2,05 m ²
Treppe	6,61 m ²
EG	73,47 m ²

Flur	6,46 m ²
Raum	14,58 m ²
Raum	14,58 m ²
Raum	14,22 m ²
Raum	14,22 m ²
Treppe	6,42 m ²
Bad	5,83 m ²
1.OG	76,32 m ²

Raum	5,48 m ²
Raum	5,83 m ²
Schlafen	29,63 m ²
Treppe	6,44 m ²
2.OG	47,39 m ²
Gesamt: 21	275,43 m ²

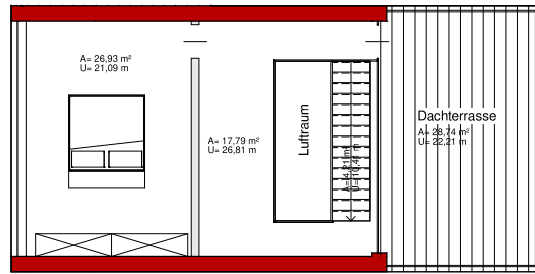

2.Obergeschoss

Reihenhaus Typ 7.1

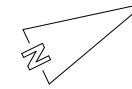

Raumbezeichnung	Fläche
-----------------	--------

Raum	43,65 m ²
1.KG	68,50 m ²

1.Obergeschoss

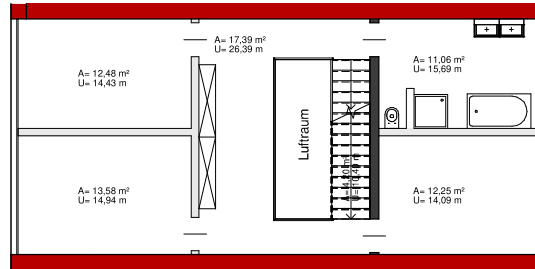

Wohnen	37,12 m ²
Eingang	12,26 m ²
Küche	11,35 m ²
WC	2,24 m ²
Treppe	3,08 m ²
EG	66,05 m ²

Galerie	17,39 m ²
Raum	13,58 m ²
Raum	12,48 m ²
Sanitär	11,06 m ²
Raum	12,25 m ²
Treppe	4,20 m ²
1.OG	70,96 m ²

Erdgeschoss

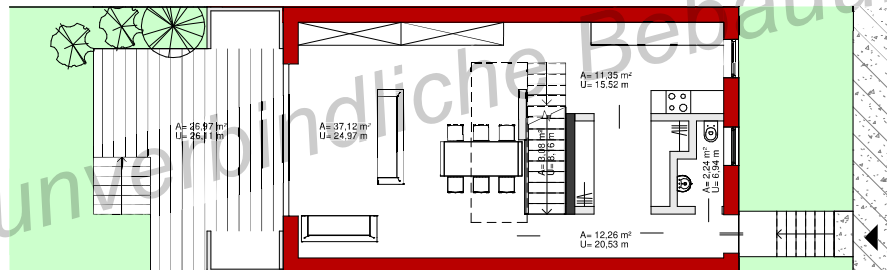

Raum	17,79 m ²
Schlafen	26,93 m ²
Treppe	4,21 m ²
2.OG	48,94 m ²
Gesamt: 16	254,45 m ²

Kellergeschoss

